



---

**BIOLOGY**

**5090/12**

Paper 1 Multiple Choice

**October/November 2019**

**1 hour**

Additional Materials: Multiple Choice Answer Sheet  
Soft clean eraser  
Soft pencil (type B or HB is recommended)



---

**READ THESE INSTRUCTIONS FIRST**

Write in soft pencil.

Do not use staples, paper clips, glue or correction fluid.

Write your name, centre number and candidate number on the Answer Sheet in the spaces provided unless this has been done for you.

**DO NOT WRITE IN ANY BARCODES.**

There are **forty** questions on this paper. Answer **all** questions. For each question there are four possible answers **A, B, C** and **D**.

Choose the **one** you consider correct and record your choice in **soft pencil** on the separate Answer Sheet.

**Read the instructions on the Answer Sheet very carefully.**

Each correct answer will score one mark. A mark will not be deducted for a wrong answer.

Any rough working should be done in this booklet.

Electronic calculators may be used.

---

This document consists of **14** printed pages and **2** blank pages.

- 1 A human cheek cell and a spongy mesophyll cell from a leaf are examined under a microscope.

Which structures are seen in both cells?

- A cell membrane, nucleus and cytoplasm
- B cell wall, cell membrane and nucleus
- C cytoplasm, cell wall and cell membrane
- D nucleus, cytoplasm and cell wall

- 2 Which statements about active transport in root hair cells are correct?

- 1 Energy is required.
- 2 Substances may be absorbed as ions.
- 3 The membrane is partially permeable.

- A 1, 2 and 3    B 1 and 2 only    C 1 and 3 only    D 2 and 3 only

- 3 Discs of raw potato tissue are weighed (initial mass). They are then placed in sucrose solutions of different concentrations. After one hour their masses are measured again (final mass).

The graph shows how the ratio of initial mass : final mass changes with concentration of sucrose solution.

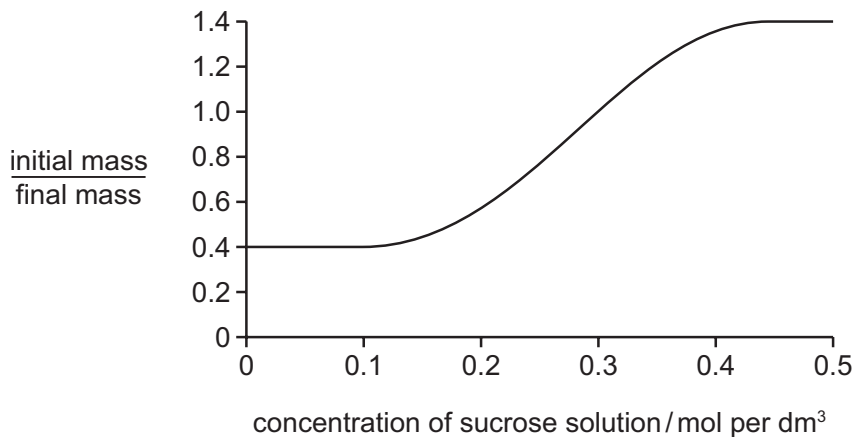

Which concentration of sucrose solution has the same water potential as that of the cells in the potato discs?

- A 0.1 mol per dm<sup>3</sup>
- B 0.3 mol per dm<sup>3</sup>
- C 0.4 mol per dm<sup>3</sup>
- D 0.5 mol per dm<sup>3</sup>

4 What happens to an enzyme after it has catalysed a reaction?

- A It can no longer fit the substrate molecules.
- B It can now catalyse several different reactions.
- C It has become part of the product molecules.
- D It is available to catalyse the same reaction again.

5 Some chemical symbols are listed.

- 1  $C_6H_{12}O_6$
- 2  $CO_2$
- 3  $H_2O$
- 4  $O_2$
- 5  $6C_6H_{12}O_6$
- 6  $6CO_2$
- 7  $6H_2O$
- 8  $6O_2$

What is the equation for photosynthesis?

- A  $1 + 8 \rightarrow 6 + 7$
- B  $3 + 4 \rightarrow 1 + 2$
- C  $6 + 7 \rightarrow 1 + 8$
- D  $6 + 7 \rightarrow 5 + 8$

6 The diagram shows some of the structures seen in a section through a dicotyledonous leaf.

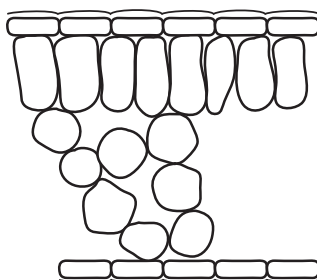

Which two features are missing from this diagram?

- A cuticle and epidermis
- B epidermis and guard cells
- C guard cells and vascular bundle
- D vascular bundle and cuticle

7 The elements listed are found in all living organisms.

Which element is **not** obtained by plants from the soil?

- A carbon
- B iron
- C magnesium
- D nitrogen

8 The table describes some characteristics of four people.

Which person requires the highest energy intake in their diet?

	age /years	sex	level of activity	body weight /kg
<b>A</b>	5	male	high	18
<b>B</b>	25	male	low	85
<b>C</b>	30	female	high	82
<b>D</b>	65	female	low	75

9 Which structure has villi to increase its surface area?

- A alveolus
- B ileum
- C root hair
- D trachea

- 10 The table shows the rates of absorption of two different sugars, arabinose and glucose, in living and dead intestines. The concentrations of the sugars inside the intestines were the same in each case.

	rate of absorption / arbitrary units	
	arabinose	glucose
living intestine	31	102
dead intestine	31	34

What are the main methods of absorption of arabinose and glucose in living intestine?

	arabinose	glucose
<b>A</b>	active transport	active transport
<b>B</b>	active transport	diffusion
<b>C</b>	diffusion	active transport
<b>D</b>	diffusion	diffusion

- 11 Which statements about root hairs are correct?

- 1 The cell membrane can allow movement of water and ions into and out of the cell.
- 2 The cell vacuole extends into the root hair.
- 3 They are formed as an extension of the outer layer of root cells.

**A** 1, 2 and 3    **B** 1 and 2 only    **C** 1 and 3 only    **D** 2 and 3 only

- 12 What is the main cause of water moving up to the leaves in xylem vessels?

- A** active transport  
**B** evaporation from the epidermis of the leaf  
**C** evaporation from the walls of the mesophyll cells  
**D** use of water in photosynthesis

- 13 Which blood vessel will have the highest urea concentration after a protein-rich meal?

- A** hepatic portal vein  
**B** hepatic vein  
**C** renal artery  
**D** renal vein

14 How does blood flow through the lungs differ from blood flow through the rest of the body?

- A Blood is pumped at a lower pressure.
- B Blood travels a greater distance.
- C The blood travels faster.
- D The volume of blood is greater.

15 Which statements about blood vessels are correct?

	arteries always carry oxygenated blood	the pulmonary vein carries deoxygenated blood
A	✓	✓
B	✓	✗
C	✗	✓
D	✗	✗

key

✓ = yes

✗ = no

16 Which equation represents anaerobic respiration in humans?

- A glucose + carbon dioxide → lactic acid
- B glucose → alcohol + carbon dioxide
- C glucose → lactic acid
- D glucose → lactic acid + carbon dioxide

17 Which process does **not** use energy released from respiration?

- A diffusion of substances down a concentration gradient
- B muscle contraction
- C production of protease enzymes in the pancreas
- D replacing heat lost from the body

18 The pie charts show the proportions of gases in samples of inspired and expired air.

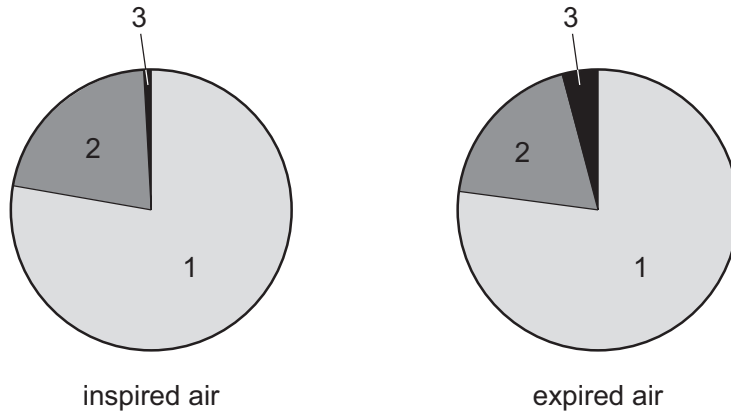

Which segments represent which gases?

	segment 1	segment 2	segment 3
<b>A</b>	nitrogen	other gases	oxygen
<b>B</b>	nitrogen	oxygen	other gases
<b>C</b>	oxygen	other gases	nitrogen
<b>D</b>	oxygen	other gases	carbon dioxide

19 In a kidney dialysis machine, which substance **cannot** diffuse through the dialysis membrane?

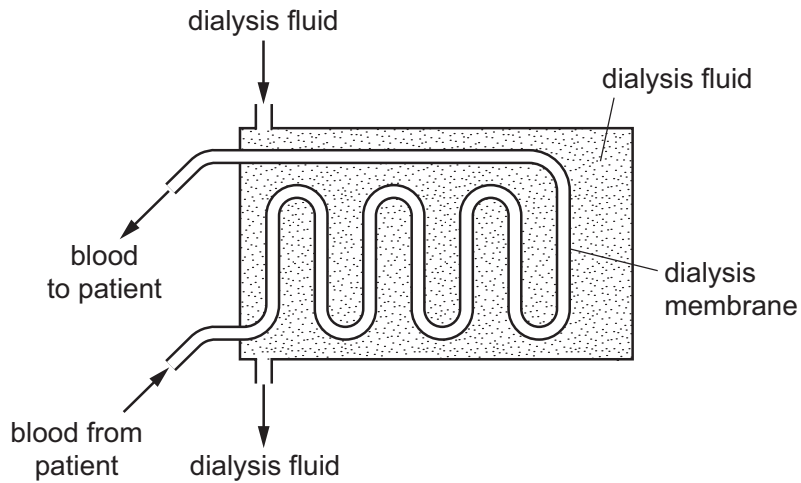

- A glucose
- B insulin
- C sodium
- D urea

20 On a hot day, the cheeks of a light-skinned person may appear red in colour.

What is the cause of this?

- A Arterioles supplying the skin have dilated.
- B Capillaries in the skin have moved closer to the surface.
- C The person has started to sweat.
- D Temperature receptors have ceased to function.

21 Which structure in the brain registers changes in the blood concentration?

- A cerebellum
- B hypothalamus
- C medulla
- D pituitary gland

22 The diagram shows a section through the skin.

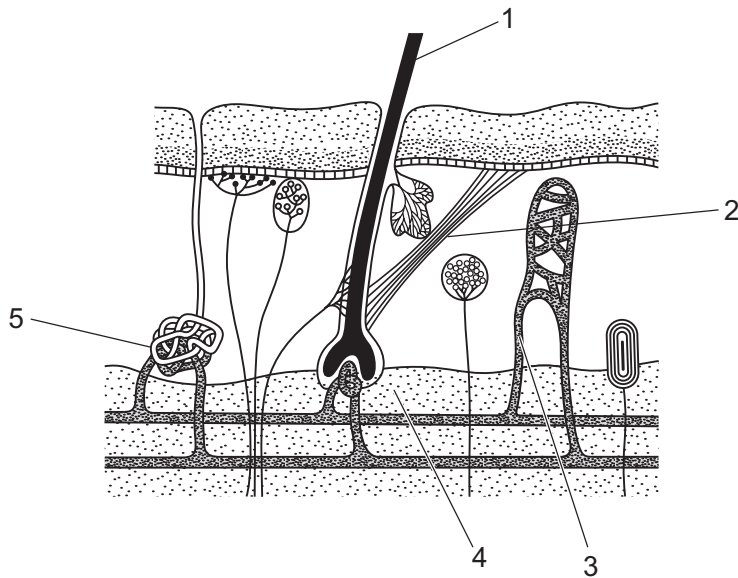

Which structures are activated when a person feels cold?

- A 1, 2 and 4
- B 1, 3 and 5
- C 2 and 3
- D 4 and 5



- 23 In which situation would the amount of insulin secreted into a person's blood be highest?
- A during a game of football
  - B having a meal of rice
  - C waking up in the early morning
  - D working outside on a cold day

- 24 The diagram shows the bones in the region of the right shoulder.

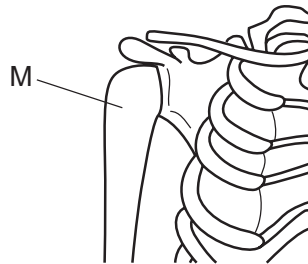

What is bone M?

- A humerus
  - B radius
  - C scapula
  - D ulna
- 25 Which risk is greatly increased by the nicotine in cigarette smoke?
- A bronchitis and emphysema
  - B cancer of the airways
  - C high blood pressure
  - D reduced birth weight of babies
- 26 Which of these organisms are microorganisms?
- 1 bacteria
  - 2 yeast
  - 3 viruses
- A 1, 2 and 3      B 1 and 3      C 1 only      D 2 and 3

- 27 Which type of organism produces penicillin, and which type of infection can be treated using penicillin?

	type of organism	type of infection treated
<b>A</b>	bacterium	bacterial
<b>B</b>	bacterium	viral
<b>C</b>	fungus	bacterial
<b>D</b>	fungus	viral

- 28 Why is the flow of energy in an ecosystem said to be non-cyclic?

- A** Energy can only be passed on in the form it entered the ecosystem.
- B** Energy can only be passed on to a larger organism.
- C** Energy cannot be completely returned to its original source.
- D** Energy cannot have its form changed within an organism.

- 29 A square metre of grassland receives 1 004 000 kJ of sunlight energy per year. The table shows what happens to this energy.

process	energy / kJ
evaporation of water from the ground	500 000
absorption by the ground	330 000
reflection from leaf surfaces	150 000
formation of new grass leaves	22 000
metabolism of grass plants (other than growth or respiration)	1 500
heat loss via grass plant respiration	500

How much of the 1 004 000 kJ of sunlight energy was used by the grass plants?

- A** 500 kJ
- B** 2000 kJ
- C** 23 500 kJ
- D** 24 000 kJ

- 30 Some bacteria survive best in waterlogged soils where they are able to obtain oxygen for respiration by breaking down nitrates. Nitrogen gas is released as a waste product.

To which type of bacteria does this description apply?

- A decomposing bacteria
  - B denitrifying bacteria
  - C nitrogen-fixing bacteria
  - D root nodule bacteria
- 31 How many times must an uninfected mosquito feed on human blood to transmit the malarial parasite in the human population?
- A only once
  - B at least twice
  - C at least three times
  - D more than three times
- 32 The diagram shows the origins of a type of pollutant entering an ocean bay.

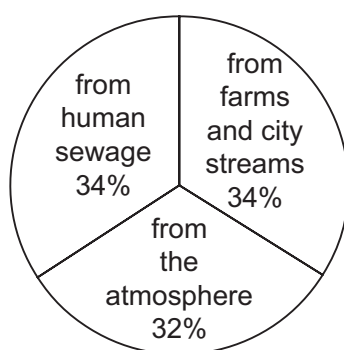

What identifies the type of pollutant?

- A carbon dioxide
  - B insecticides
  - C methane
  - D nitrogen-containing chemicals
- 33 Which structure contains the ovary of a flowering plant?
- A anther
  - B carpel
  - C ovule
  - D pollen grain

34 The diagram shows the life cycle of a species of plant.

During which stage does meiosis (reduction division) occur?

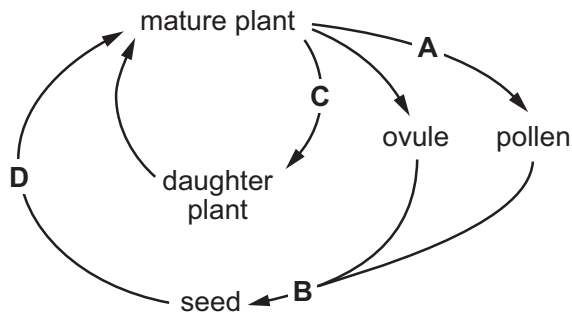

35 The diagram shows the female reproductive system.

Where does implantation occur?

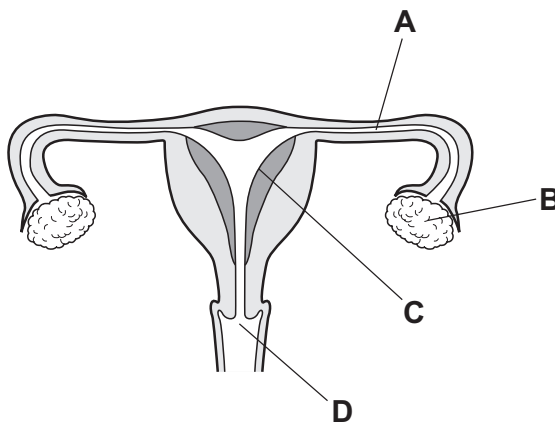

36 In the control of female fertility, which hormones could be used for preventing ovulation, and which could be used for promoting ovulation?

	preventing ovulation	promoting ovulation
<b>A</b>	FSH	LH and progesterone
<b>B</b>	LH	oestrogen and progesterone
<b>C</b>	LH and oestrogen	progesterone
<b>D</b>	oestrogen and progesterone	FSH

37 A student wrote some statements about chromosomes, but made a number of mistakes.

- 1 There are 46 pairs of chromosomes in a human body cell.
- 2 In gametes, chromosomes are found in pairs.
- 3 Males have one X and one Y chromosome in each body cell.
- 4 Chromosomes contain a long DNA molecule divided into sections called genes.
- 5 Chromosomes include genes which are divided into sections called DNA molecules.

Which two statements are correct?

- A** 1 and 2      **B** 1 and 3      **C** 2 and 5      **D** 3 and 4

38 Elephants are hunted by poachers for their tusks, which are a source of ivory. In 1930, in a National Park, 1% of the elephants were born without any tusks. Lack of tusks was the result of a gene mutation. Currently, in the same area, 15% of the females and 9% of the males do not have tusks.

Which statements can explain this increase in the number of tuskless elephants?

- 1 Selection against tusked elephants is occurring.
- 2 Tuskless elephants are less likely to be killed by poachers.
- 3 Tuskless elephants reproduce and pass the allele to their offspring.

- A** 1, 2 and 3      **B** 1 and 2 only      **C** 1 only      **D** 2 and 3 only

39 The diagram shows a family tree in which hereditary night-blindness occurs.

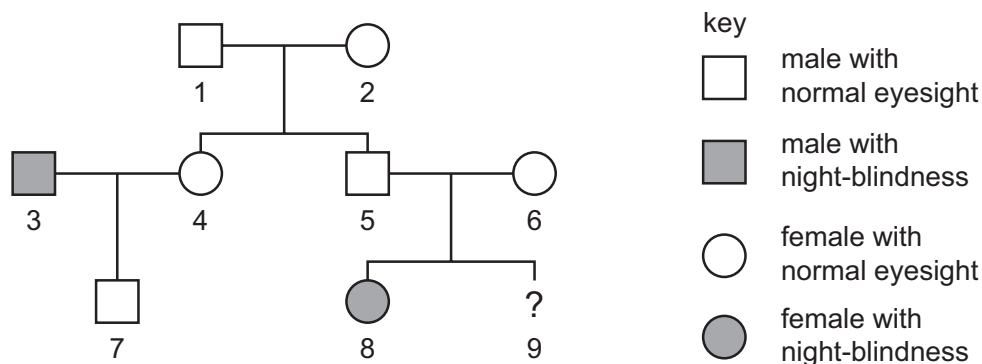

What is the chance that unborn child, 9, will be a male with night-blindness?

- A** 1 in 2      **B** 1 in 4      **C** 1 in 8      **D** 3 in 4

- 40 Which statement about dominant and recessive alleles is **not** correct?
- A A dominant characteristic is seen in the phenotype of a heterozygote.
  - B A homozygous genotype may be either dominant or recessive.
  - C Recessive phenotypes always have two recessive alleles.
  - D The phenotype of a homozygote is always dominant.



**BLANK PAGE**

---

Permission to reproduce items where third-party owned material protected by copyright is included has been sought and cleared where possible. Every reasonable effort has been made by the publisher (UCLES) to trace copyright holders, but if any items requiring clearance have unwittingly been included, the publisher will be pleased to make amends at the earliest possible opportunity.

To avoid the issue of disclosure of answer-related information to candidates, all copyright acknowledgements are reproduced online in the Cambridge Assessment International Education Copyright Acknowledgements Booklet. This is produced for each series of examinations and is freely available to download at [www.cambridgeinternational.org](http://www.cambridgeinternational.org) after the live examination series.

Cambridge Assessment International Education is part of the Cambridge Assessment Group. Cambridge Assessment is the brand name of the University of Cambridge Local Examinations Syndicate (UCLES), which itself is a department of the University of Cambridge.